

RGBlink® | aura



aura UHD 24 / aura UHD 27 / aura UHD 32
12G-SDI Professional Film and Television Production Monitor



aura

aura UHD 24 / aura UHD 27 / aura UHD 32

12G-SDI Professional Film and Television Production Monitor

This series is broadcast 4K HDR monitor, equipped with UHD (3840x2160) screen, supports 4-channel single-link 12G-SDI, quad-link 4K SDI and HDMI2.0 signal input, supports high-precision 3D LUT with tetrahedral interpolation algorithm, supports HDR formats such as SMPTE ST2084(PQ), hybrid log-gamma HLG, various Gamma curves, camera Log and other professional functions which are widely used in pre-shooting and post-grading work in broadcasting, film, television, and high-end advertising production.

Overview

4K IPS LCD Panel

24/27/32 inch available

4K UHD LCD panel, with ultra high resolution 3840x2160, the color depth up to 10bit and display 1.07B colors, and offers the precise colors and performance to get video and visual media content to be exactly as intended.

aura UHD 24	UHD 3840x2160	540nit Brightness	10Bit 1.07B Colors	1200:1 Contrast	178° Viewing Angle
aura UHD 27	UHD 3840x2160	800nit Brightness	10Bit 1.07B Colors	1200:1 Contrast	178° Viewing Angle
aura UHD 32	UHD 3840x2160	700nit Brightness	10Bit 1.07B Colors	1200:1 Contrast	178° Viewing Angle

wide color gamut

for broadcast TV and film standards

aura UHD monitor covers 100% Rec. 709 and 98% DCI-P3 wide color gamut, presenting rich color. And supports ITU-R BT.2020, ITU-R BT.709, EBU, SMPTE-C, Native and other color gamuts, meet the different needs of photographers for color gamut.

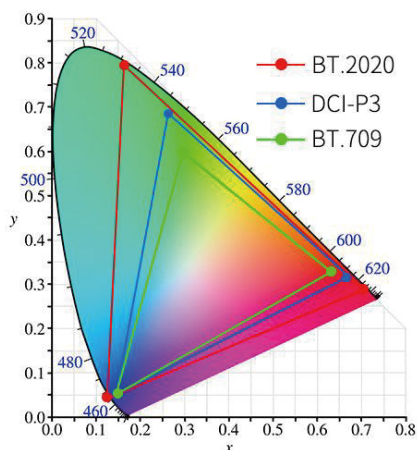

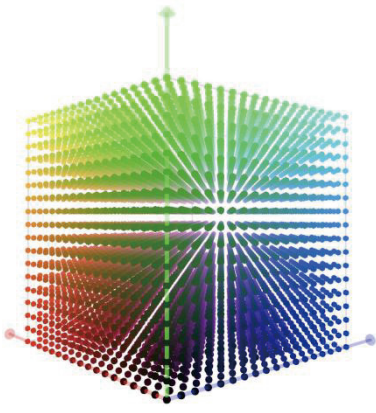

Accurate 3D LUT Color Calibration & Rainbow Color Management Engine

aura UHD adopts a high-precision 3D LUT that supports tetrahedral interpolation algorithm, and built-in Rainbow color management engine, ensures aura uhd series has accurate color reproduction capabilities.

Aluminum Alloy Frame

rugged and durable, easy to dissipate heat.

The full aluminum alloy frame not only make the device more solid and durable, but also solve the problem of heat dissipation.



Flexible and Intuitive Button Operation

When you are busy during the shooting, you need to be able to easily control the equipment, and this aura UHD series can meet your needs. It can switch between one-button sources, custom shortcuts, and quickly call out menu, etc. to make shooting easier. The backlight button design makes it easier for you to distinguish the current input signal and the shortcut keys used, easy to use even in dimly lit studio or outdoor environments.

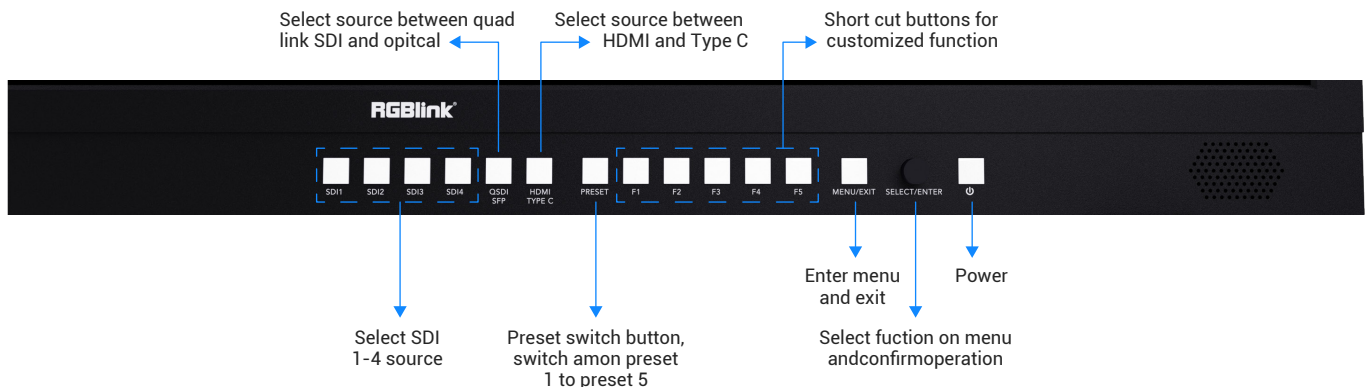

12G-SDI /8K/4K HDMI Signal

Bringing you a new visual experience

When you need a higher quality SDI monitoring for 4K or 8K video, aura UHD series is the perfect choice. It comes with 4*12G-SDI inputs and outputs, support up to 8K signal input, allow for multiple configurations of input, 1*HDMI 2.0 inputs, support up to 4096x2160p(60/59.94/50/30/29.97/25/24/23.98) & 3840x2160p(60/50/30/25/24) signal. Corresponding to the refresh of 60 frames per second, 4K audio and video transmission can be solved just over a single cable, reducing costs and ensuring high quality image, bringing you a new visual experience!

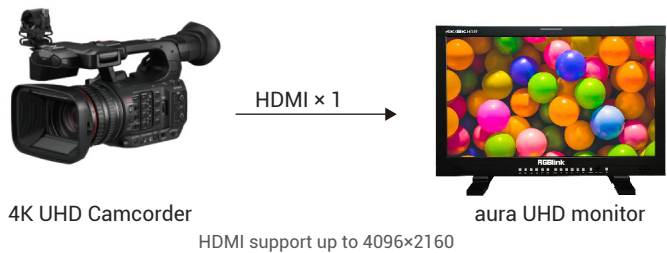
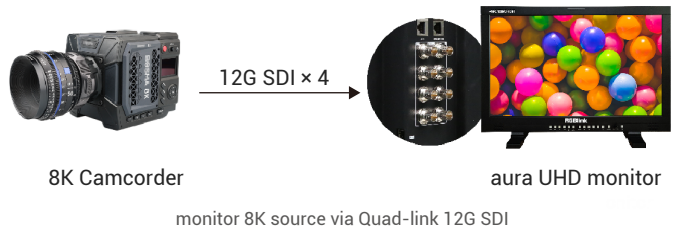

12G-SFP Fiber Port

Seamless, high-speed, reliable data communication connection

This series comes with SFP interface compatible with universal SFP or SFP + fiber optical module, is an essential part of high-speed telecommunications and data communications, especially in large network environments, which allows for the receiving of broadcast quality transmission level video data over a fiber optic connection. Used by many TV broadcasters, fiber optic input is the industry standard for the control room as video transmission technology.

Note: SFP module is optional.

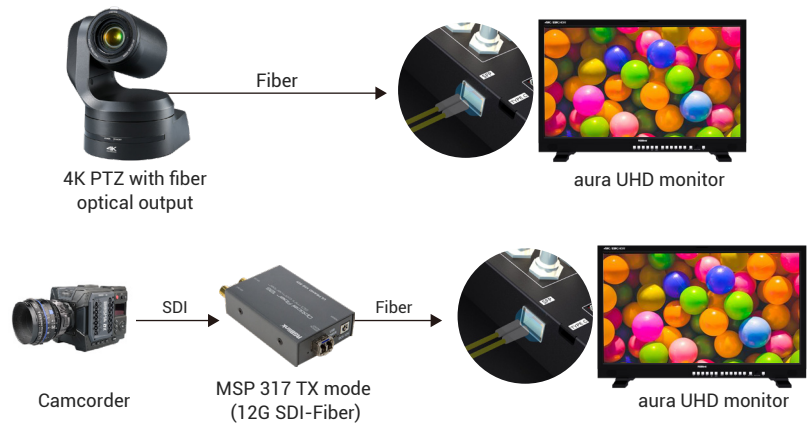

USB-C (Thunderbolt) Input Port

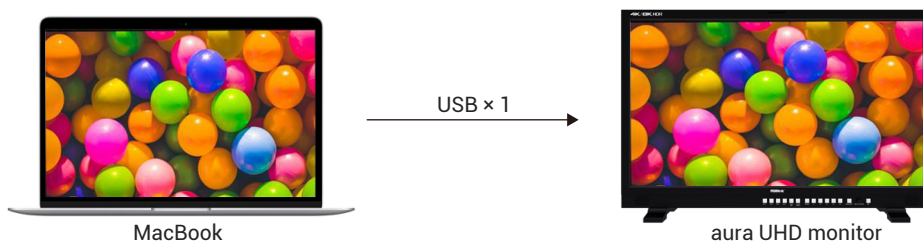

Professional On Set Monitoring Tools

Accurately focus and efficient monitoring

aura UHD series provides a series professional auxiliary monitoring tools, such as waveform, 3D-LUT, central marker, histogram, vector scope, audio meter, time code, image flip, etc. All these functions are easy to select and operate from OSD menu which greatly improves the efficiency of on-site shooting and post-production.

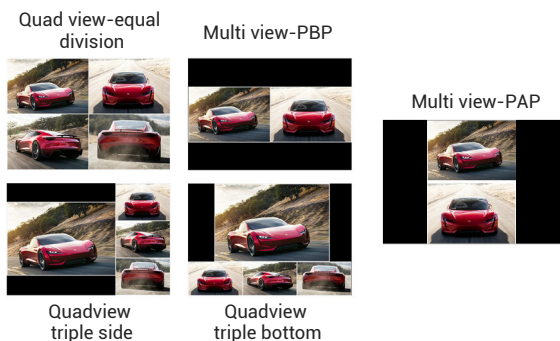
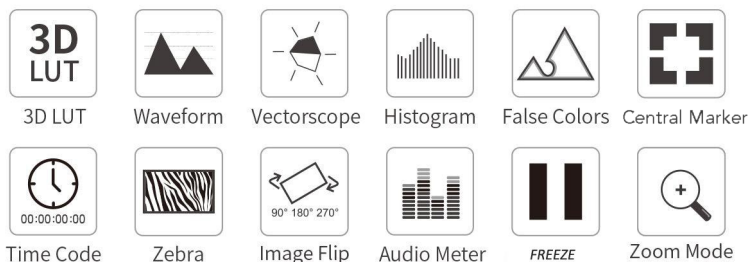

Multiple Screen Modes

Perfect choice for multiple camera monitoring

aura UHD series supports quad view, Quadview triple side, Quadview triple bottom, PBP, PAP multi display mode optional, one monitor can satisfy multi-camera monitoring.

Note: Screen C can only display HDMI 2 and TYPE C.

SDR and HDR Image Comparison Function

Supports HDR mode/Gamma(EOTF)

aura UHD series can perform SDR and HDR image comparison monitoring in multi-view mode, supports HLG (1.0, 1.1, 1.2, 1.3, 1.4, 1.5) mixed log gamma, ST.2084 Dolby Vision PQ, Sony S-log3 HDR, various common gamma and user Gamma LUT upload.

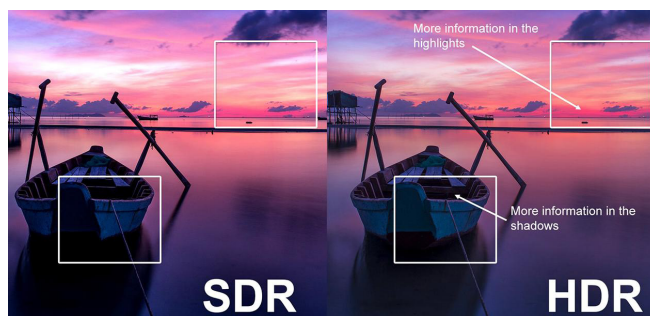

Payload ID Automatically Setting

aura UHD series can read the Payload ID information of the SDI input signal source, and automatically select the color gamut, EOTF (PQ or HLG) curve.



3D LUT, Recreate Film Looks

3D-LUT is a table for quickly looking up and output specific color data. By loading different 3D-LUT tables, it can quickly recombine color tone to form different color styles. Built-in 9 DE-log LUT, you also can load the customized "*.cube" file by the dedicated software.



Dynamic UMD TSL3.1/4.0/5.0 Protocol

aura UHD supports UMD of TSL 3.1/4.0/5.0 protocol allowing 8 letters to be displayed for single channel and gives the chance to the producer at a glance and to find out if the dedicated signal source is being switched.



Three Color Tally Lights

GPI controls Red Tally, Green Tally and Yellow Tally, which not only can remind the photographer to enter the recording state, but also appreciate the convenience of TV shooting quasi-professional technology in your creation.



Professional Audio Meters

aura UHD series can de-embed audio from SDI and HDMI. It can support up to 16 channels display and users can select any 2 channels audio to output via speaker or 3.5mm headphone jack. The audio meters can be displayed In vertical or horizontal orientation.



VESA mounting points

aura UHD24 comes with 100×100mm VESA mounting ; aura UHD 27 & aura UHD 32 each come with 100×100 and 200×200mm VESA mounting points; you can easily hang it on articulated arm or wall for a busy newsroom.

Note: articulated arm is not supplied.



Specification

aura UHD Series 4K/8K HDR Monitor

Model	aura UHD 24	aura UHD 27	aura UHD 32
Physical			
Net Weight	8.6 kg	11.4kg	15.3kg
Packaged Weight	12 kg	15.3 kg	20.6 kg
Net Dimension	571.7 × 160 × 414.85 mm	661 × 420 × 179 mm	751 × 502 × 179 mm
Packaged Dimension	800 × 250 × 555 mm	890 × 270 × 595 mm	980 × 270 × 675 mm
Performance			
Size	23.8 inch	27 inch	32 inch
Brightness	540 cd/m2	800 cd/m2	700 cd/m2
Power			
Power Consumption (Max)	90 W	98 W	132 W
Input Voltage	AC100~240V 50/60Hz	AC100~240V 50/60Hz	AC100~240V 50/60Hz

Connectors

Input	12G-SDI	4xBNC
	HDMI 2.0	2xHDMI-A
	SFP	12G Fiber
	Type-C/Thunderbolt3	1xUSB-C
Output	12G-SDI	4xBNC

Performance

Panel	Type	LCD IPS Panel
	Resolution	3840 × 2160
	Pixel Pitch	0.1369 (H) × 0.1369 (V) mm
	Aspect Ratio	16:9 Backlight LED
	Contrast Ratio	1200:1
	Color Depth	10bits(1.07B)
	Image Processing	12bits
	Response	9ms
	Viewing Angle	178°/178°

Performance

Audio	Audio de-embedding	Support
	Audio Meter	16 channels (Up to 8 channels can be displayed simultaneously.)
	Built-in speaker	1×8 ohm/0.5W
	Headphone	Stereo mini jack×1
General	Control/Update	1×RJ45
	GPI	GPI1-5, 1×RJ-45
	Serial port	RS-422, 2×RJ-45 (1 in 1 out)

Environment

Operating Temperature	-10℃ ~ 55℃ (14°F to 155°F)
Operating Humidity	30% ~ 85%, RH
Storage Humidity	-20-60℃

Video Signal Format

SDI Signal Format

SMPTE-425M-A/B:1080p@50/59.94/60;
SMPTE-274M:1080p@23.98/24/25/29.97/30;
SMPTE-296M:720p@50/59.94/60;
SMPTE ST 2036-1:2009:3840×2160p@23.98/24/25/29.97/30/50/59.94/60;
SMPTE ST 2048-2:2011:2048×1080@23.98/24/25/29.97/30p/psf,
47.95/48/50/59.94/60p;
SMPTE ST 2081:3840×2160p@24/25/30;
SMPTE ST 2082:3840×2160p@24/25/30/50/60;

HDMI Signal Format

720p@50/59.94/60;1080i@50/59.94/60;
1080p@23.98/24/25/29.97/30/50/59.94/60;
3840×2160p@23.98/24/25/29.97/30/50/59.94/60;
4096×2160p@23.98/24/25/29.97/30/50/59.94/60;

Order Codes

Product Code	Item
400-2380-02-0	aura UHD 24
400-2700-02-0	aura UHD 27
400-3200-02-0	aura UHD 32

