

MSP 311

HDMI 2.0 Audio Extractor with HDCP 2.2

USER MANUAL

RGBlink[®]

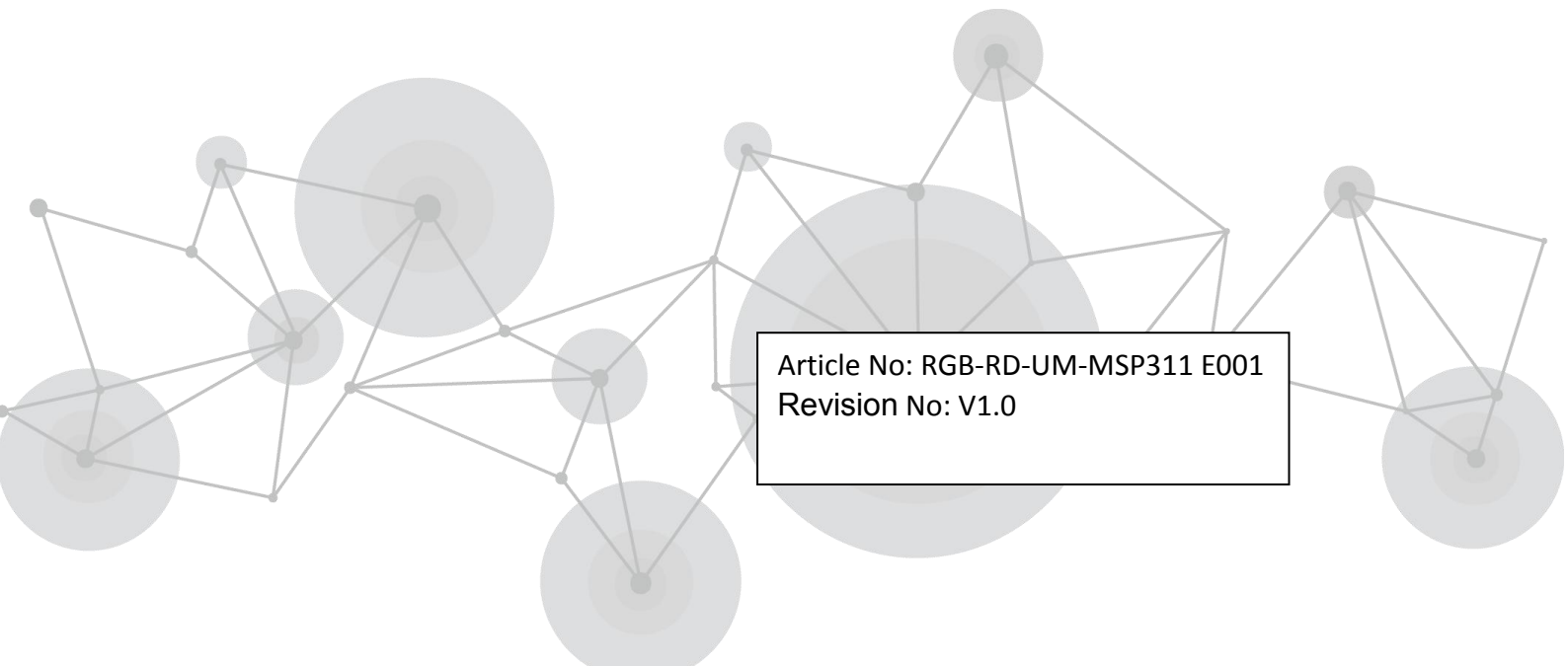

Article No: RGB-RD-UM-MSP311 E001
Revision No: V1.0

CONTENTS

CONTENTS.....	1
<i>Declarations</i>	2
FCC/Warranty.....	2
Operators Safety Summary.....	3
Installation Safety Summary.....	4
<i>Chapter 1 Your Product</i>	5
1.1 In the Box.....	5
1.2 Product Overview.....	6
1.2.1 Front Panel.....	7
1.2.2 Back Panel.....	7
1.2.3 Dimension.....	8
<i>Chapter 2 Use Your Product</i>	9
2.1 Operation Steps.....	9
<i>Chapter 3 Order Codes</i>	10
4.1 Product.....	10
4.2 Other.....	10
<i>Chapter 4 Support</i>	11
4.1 Contact Us.....	11
<i>Chapter 5 Appendix</i>	12
5.1 Specification.....	12
5.2 MSP Garage Installation.....	14
5.3 Terms & Definitions.....	16
5.4 Revision History.....	21

Thank you for choosing our product!

This User Manual is designed to show you how to use this video processor quickly and make use of all the features. Please read all directions and instructions carefully before using this product.

Declarations

FCC/Warranty

Federal Communications Commission (FCC)

Statement

This equipment has been tested and found to comply with the limits for a class A digital device, pursuant to Part 15 of the FCC rules. These limits are designed to provide reasonable protection against harmful interference when the equipment is operated in a commercial environment. This equipment generates, uses, and can radiate radio frequency energy and, if not installed and used in accordance with the instruction manual, may cause harmful interference to radio communications. Operation of this equipment in a residential area may cause harmful interference, in which case the user will be responsible for correcting any interference.

Guarantee and Compensation

RGBlink provides a guarantee relating to perfect manufacturing as part of the legally stipulated terms of guarantee. On receipt, the purchaser must immediately inspect all delivered goods for damage incurred during transport, as well as for material and manufacturing faults. RGBlink must be informed immediately in writing of any complains.

The period of guarantee begins on the date of transfer of risks, in the case of special systems and software on the date of commissioning, at latest 30 days after the transfer of risks. In the event of justified notice of compliant, RGBlink can repair the fault or provide a replacement at its own discretion within an appropriate period. If this measure proves to be impossible or unsuccessful, the purchaser can demand a reduction in the purchase price or cancellation of the contract. All other claims, in particular those relating to compensation for direct or indirect damage, and also damage attributed to the operation of software as well as to other service provided by RGBlink, being a component of the system or independent service, will be deemed invalid provided the damage is not proven to be attributed to the absence of properties guaranteed in writing or due to the intent or gross negligence or part of RGBlink.

If the purchaser or a third party carries out modifications or repairs on goods delivered by RGBlink, or if the goods are handled incorrectly, in particular if the systems are

commissioned operated incorrectly or if, after the transfer of risks, the goods are subject to influences not agreed upon in the contract, all guarantee claims of the purchaser will be rendered invalid. Not included in the guarantee coverage are system failures which are attributed to programs or special electronic circuitry provided by the purchaser, e.g. interfaces. Normal wear as well as normal maintenance are not subject to the guarantee provided by RGBlink either.

The environmental conditions as well as the servicing and maintenance regulations specified in this manual must be complied with by the customer.

Operators Safety Summary

The general safety information in this summary is for operating personnel.

Do Not Remove Covers or Panels

There are no user-serviceable parts within the unit. Removal of the top cover will expose dangerous voltages. To avoid personal injury, do not remove the top cover. Do not operate the unit without the cover installed.

Power Source

This product is intended to operate from a power source that will not apply more than 230 volts rms between the supply conductors or between both supply conductor and ground. A protective ground connection by way of grounding conductor in the power cord is essential for safe operation.

Grounding the Product

This product is grounded through the grounding conductor of the power cord. To avoid electrical shock, plug the power cord into a properly wired receptacle before connecting to the product input or output terminals. A protective-ground connection by way of the grounding conductor in the power cord is essential for safe operation.

Use the Proper Power Cord

Use only the power cord and connector specified for your product. Use only a power cord that is in good condition. Refer cord and connector changes to qualified service personnel.

Use the Proper Fuse

To avoid fire hazard, use only the fuse having identical type, voltage rating, and current rating characteristics. Refer fuse replacement to qualified service personnel.

Do Not Operate in Explosive Atmospheres

To avoid explosion, do not operate this product in an explosive atmosphere.

Installation Safety Summary

Safety Precautions

For all MSP 315 processor installation procedures, please observe the following important safety and handling rules to avoid damage to yourself and the equipment.

To protect users from electric shock, ensure that the chassis connects to earth via the ground wire provided in the AC power Cord.

The AC Socket-outlet should be installed near the equipment and be easily accessible.

Unpacking and Inspection

Before opening MSP 315 processor shipping box, inspect it for damage. If you find any damage, notify the shipping carrier immediately for all claims adjustments. As you open the box, compare its contents against the packing slip. If you find any shortages, contact your sales representative.

Once you have removed all the components from their packaging and checked that all the listed components are present, visually inspect the system to ensure there was no damage during shipping. If there is damage, notify the shipping carrier immediately for all claims adjustments.

Site Preparation

The environment in which you install your MSP 315 should be clean, properly lit, free from static, and have adequate power, ventilation, and space for all components.

Chapter 1 Your Product

1.1 In the Box



1.2 Product Overview

The MSP 311 HDMI 2.0 Audio Extractor with HDCP 2.2 could extract audio signals from any HDMI compliant source to digital optical or analog stereo L/R audio outputs. Further, both input and output HDMI support video resolution up to 4K 2K@50/60Hz (YUV4:4:4). It supports 10bits HDR(High Dynamic Range) pass through and HDMI high resolution digital audio formats bypass, LPCM 2CH, Dolby True HD, Dolby Digital Plus, Dolby Atmos and DTS-HD Master Audio, audio sampling rate up to 192kHz. HDCP 2.2 and CEC bypass are supported.

The key features are as follows:

- HDMI 2.0b (18Gbps), HDCP 2.2 and DVI compliant
- Video resolutions up to 4K2K@50/60Hz (YUV444)
- Extracts HDMI audio to multi-channel optical (SPDIF) or L/R analog audio
- Optical audio supports LPCM 2CH, Dobby Digital 2/5.1 CH, DTS 2/5.1CH
- Supports HDMI High Bit Rate(HBR) audio pass through
- Audio sample rates up to 192kHz
- 10bits HDR (High Dynamic Range) pass through
- Supports CEC bypass
- Supports rack mount installation

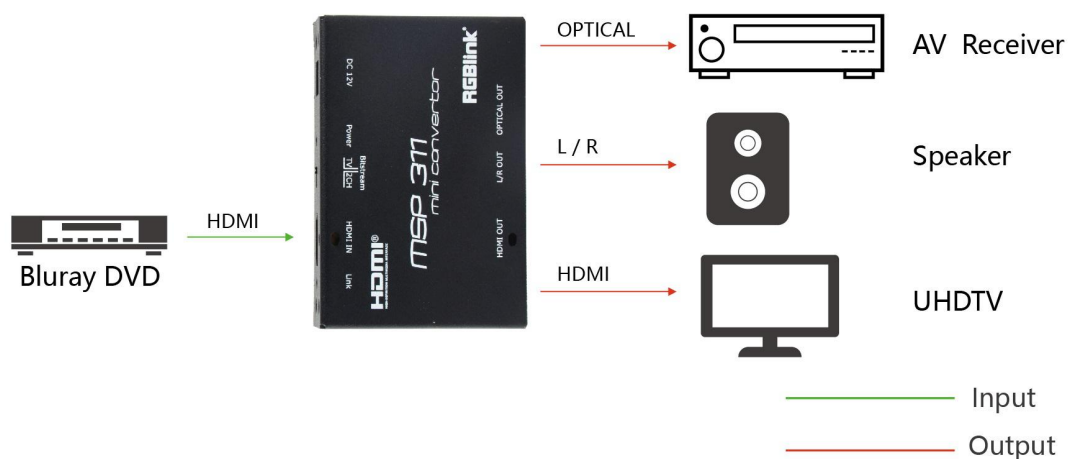

MSP 311 System Connection Diagram

1.2.1 Front Panel

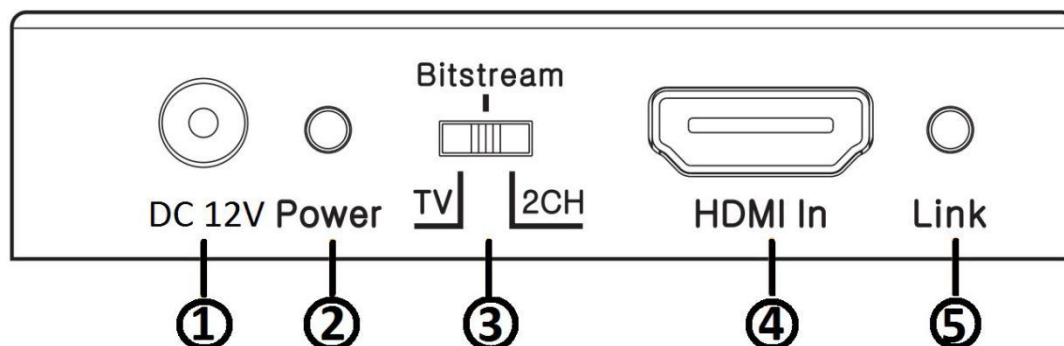

Illumination			
1	DC 12V, connect to DC 12V/1.5A to AC wall outlet for power supply	2	Power LED indicator
3	Switch, allow users to select audio format according to TV/bitstream/LPCM 2CH	4	HDMI IN (HDMI Type A, HDMI input port to connect to HDMI output of PC or Blu-ray player)
5	Link Led indicator, when HDMI signal is detected, it will illuminate.		

1.2.2 Back Panel

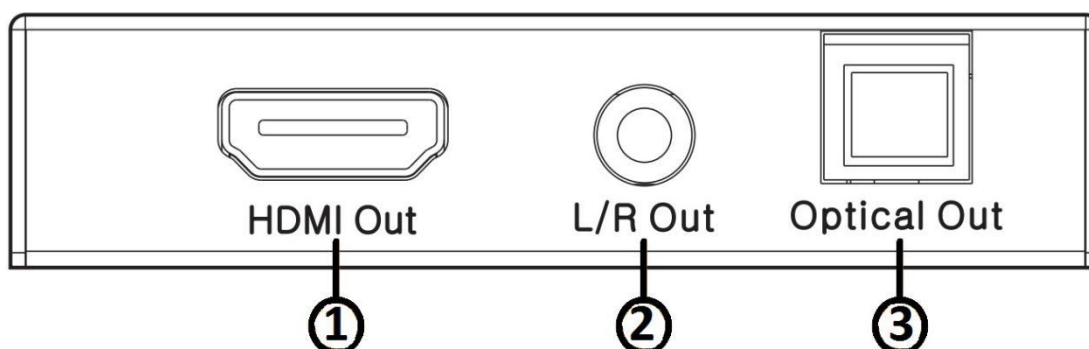

Illumination			
1	HDMI OUT (connect to HDMI port of HD display such as TV or projector)	2	L/R Out, Connect to earphone or L/R input on TV
3	Optical Out connect, connect to audio optical input port on amplifier		

1.2.3 Dimension

Following is the dimension of MSP 311 for your reference:

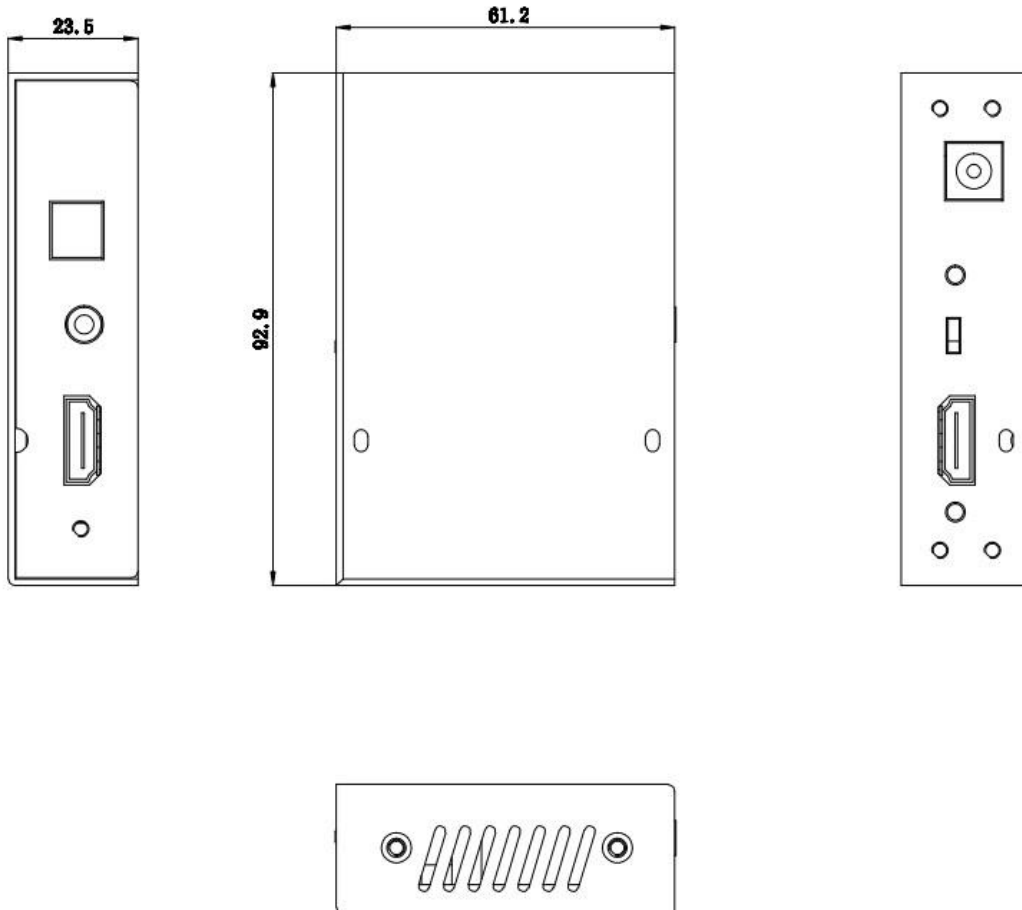

Chapter 2 Use Your Product

2.1 Operation Steps

1. Connect HDMI port of bluray player or PC to “HDMI IN” on MSP 311 and connect “HDMI Out” on MSP 311 HDMI port on HD Display or projector by premium HDMI cable.
2. Use digital optical audio cable to connect “Optical Out” on MSP 311 to amplifier SDPIF input port
3. Use 3.5mm audio cable to connect L/R out on MSP 311 to earphone or loudspeaker
4. Supply power to MSP 311 via 12V/1.5A adaptor.

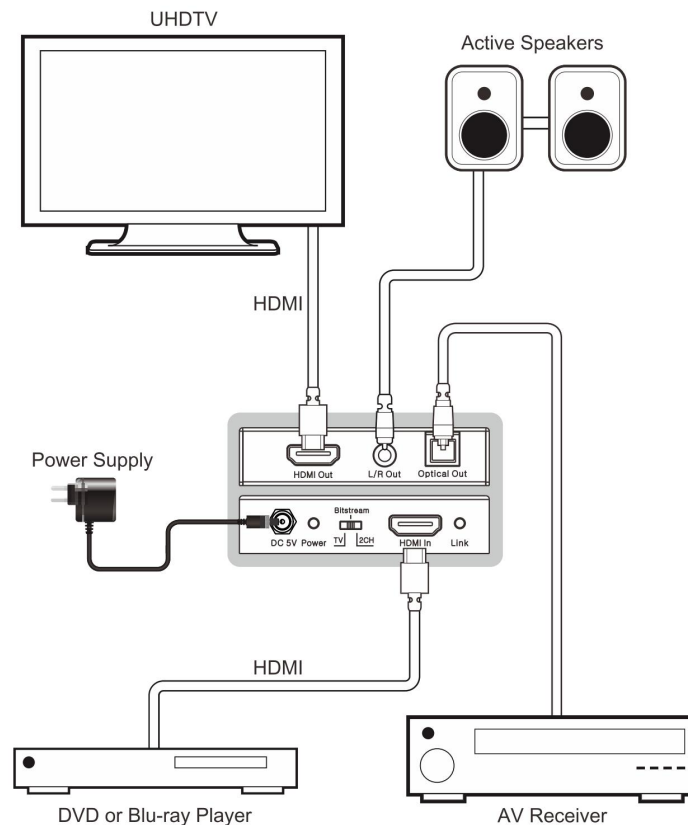

Chapter 3 Order Codes

4.1 Product

621-0311-01-1 MSP 311

4.2 Other

920-0005-01-0 MSP Garage with PSU

Chapter 4 Support

4.1 Contact Us

Contact Us



Web
www.rgblink.com

Phone
+86-592-577-1197

Email
Sales sales@rgblink.com
Support support@rgblink.com

Social Media



Chapter 5 Appendix

5.1 Specification

Connector		
Input	HDMI 2.0	1×HDMI Type A
Output	Optical out	1×SPDI/F
	L/R Out	1×3.5mm jack
	HDMI 2.0	1×HDMI Type A
Performance		
Supported Input Resolutions	SMPTE	720p@23.98/24/25/29.97/30/50/59.94/60 1080p@23.98/24/25/29.97/30/50/59.94/60 2160p@24/30/50/60
	VESA	800x600@60 1024x768@60 1280x768@60 1280x1024@60 1366x768@60 1600x1200@60 1920x1080@60 2048x1152@60 2560x1600@60 3840x1080@60 3840x2160@24/30/50/60
Supported Output Resolutions	SMPTE	720p@23.98/24/25/29.97/30/50/59.94/60 1080p@23.98/24/25/29.97/30/50/59.94/60 2160p@24/30/50/60
	VESA	800x600@60 1024x768@60 1280x768@60 1280x1024@60 1366x768@60 1600x1200@60 1920x1080@60 2048x1152@60 2560x1600@60 3840x1080@60 3840x2160@24/30/50/60
Audio Format	HDMI	PCM2, 5.1, 7.1CH, Dolby Digital, DTS 5.1, Dolby Digital+, Dolby TrueHD, DTS-HD Master Audio, Dolby Atmos, DTS:X
	Optical	LPCM 2CH, LPCM 5.1, Dolby Digital 2/5.1CH, DTS 2/5.1CH
	L/R	Analog stereo 2CH
Color Space	RGB, YCbCr 4:4:4, YCbCr 4:2:2	

Bit Depth	8-bit, 10-bit, 12-bit	
General		
Input Voltage	DC 12V/1.5A	
Working Temperature	0°C ~ 40°C / 32°F ~ 104°F	
Storage Temperature	-20°C ~ 60°C / -4°F ~ 140°F	
Humidity	20 - 95%	
Weight	Nett	0.13kg
	Packaged	0.43kg
Dimensions	Nett	93mm × 61mm × 24mm
	Packaged	160mm × 120mm×80mm

5.2 MSP Garage Installation

1. Unscrew the fixed screws with a screwdriver, and remove the block, as shown in figure:

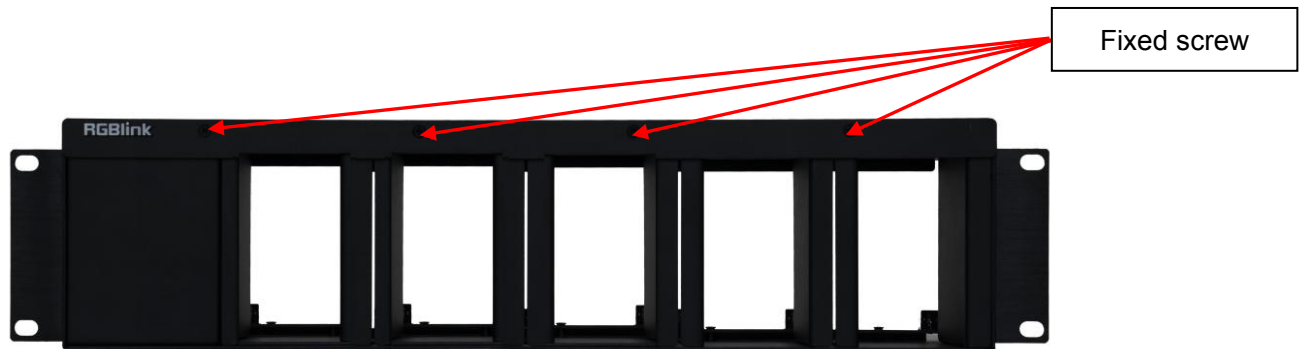

2. Install the small converters to the slots, as shown in figure:



3. Fix the block to the MSP rack with fixed screws, as shown in figure:

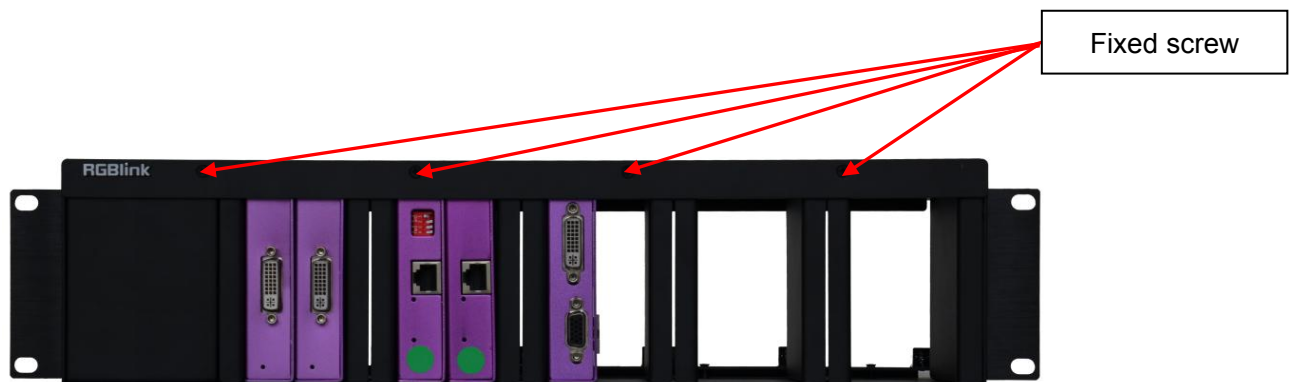

4. Connect one end of the DC power cord to the DC 12V power interface of the MSP rack and the other end to the power interface of the small converter, as shown in figure:



According to above method, connect the small converters one by one with the DC power cords, user can install up to 10 different types of small converters in one frame.

5. Connect the small converters to the devices with the specific cables.
6. Plug in the power cord (AC 85~264V IEC-3 port), and push the power switch to the ON position, the device will enter normal working.

5.3 Terms & Definitions

The following terms and definitions are used throughout this guide.

- **“ASCII”**: American Standard for Information Interchange. The standard code consisting of 7-bit coded characters (8 bits including parity check) used to exchange information between data processing systems, data communication systems, and associated equipment. The ASCII set contains control characters and graphic characters.
- **“Aspect ratio”**: The relationship of the horizontal dimension to the vertical dimension of an image. In viewing screens, standard TV is 4:3, or 1.33:1; HDTV is 16:9, or 1.78:1. Sometimes the “:1” is implicit, making TV = 1.33 and HDTV = 1.78.
- **“AV”**: Audio visual, or audio video.
- A **“Background”** is an unscaled source, typically originating from a computer. A background source appears at the system’s lowest priority — visually in back of all other sources.
- **“Baudrate”**: Named of J.M.E. Baudot, the inventor of the Baudot telegraph code. The number of the electrical oscillations per second, called baud rate. Related to, but not the same as, transfer rate in bits per second (bps).
- **“Blackburst”**: The video waveform without the video elements. It includes the vertical sync, horizontal sync, and the chroma burst information. Blackburst is used to synchronize video equipment to align the video output. One signal is normally used to set up an entire video system or facility. Sometimes it is called House sync.
- **“BNC”**: Bayonet Neill-Concelman. A cable connector used extensively in television and named for its inventors. A cylindrical bayonet connector that operates with a twist-locking motion. To make the connection, align the two curved grooves in the collar of the male connector with the two projections on the outside of the female collar, push, and twist. This allows the connector to lock into place without tools.
- **“Brightness”**: Usually refers to the amount or intensity of video light produced on a screen without regard to color. Sometimes called “black level.”
- **“CAT 5”**: Category 5. Describes the network cabling standard that consists of four unshielded twisted pairs of copper wire terminated by RJ-45 connectors. CAT 5 cabling supports data rates up to 100 Mbps. CAT 5 is based on the EIA/TIA 568 Commercial Building Telecommunications Wiring Standard.
- **“Color bars”**: A standard test pattern of several basic colors (white, yellow, cyan, green, magenta, red, blue, and black) as a reference for system alignment and testing. In NTSC video, the most commonly used color bars are the SMPTE standard color bars. In PAL video, the most commonly used color bars are eight full field bars. In the computer, the most commonly used color bars are two rows of reversed color bars.
- **“Color burst”**: In color TV systems, a burst of subcarrier frequency located on the back porch of the composite video signal. This serves as a color synchronizing

signal to establish a frequency and phase reference for the chroma signal. Color burst is 3.58 MHz for NTSC and 4.43 MHz for PAL.

“Color temperature”: The color quality, expressed in degrees Kelvin(K), of a light source. The

- higher the color temperature, the bluer the light. The lower the temperature, the redder the light. Benchmark color temperature for the A/V industry include 5000°K, 6500°K, and 9000°K.
- **“Contrast ratio”**: The ratio of the high light output level divided by the low light output level. In theory, the contrast ratio of the television system should be at least 100:1, if not 300:1. In reality, there are several limitations. In the CRT, light from adjacent elements contaminate the area of each element. Room ambient light will contaminate the light emitted from the CRT. Well-controlled viewing conditions should yield a practical contrast ratio of 30:1 to 50:1.
- **“DVI”**: Digital Visual Interface. The digital video connectivity standard that was developed by DDWG (Digital Display Work Group). This connection standard offers two different connectors: one with 24 pins that handles digital video signals only, and one with 29 pins that handles both digital and analog video.
- **“EDID”**: Extended Display Identification Data – EDID is a data structure used to communicate video display information, including native resolution and vertical interval refresh rate requirements, to a source device. The source device will then output the optimal video format for the display based on the provided EDID data, ensuring proper video image quality. This communication takes place over the DDC – Display Data Channel.
- **“Ethernet”**: A Local Area Network (LAN) standard officially known as IEEE 802.3. Ethernet and other LAN technologies are used for interconnecting computers, printers, workstations, terminals, servers, etc. within the same building or campus. Ethernet operates over twisted pair and over coaxial cable at speeds starting at 10Mbps. For LAN interconnectivity, Ethernet is physical link and data link protocol reflecting the two lowest layers of the OSI Reference Model.
- **“Frame”**: In interlaced video, a frame is one complete picture. A video frame is made up of two fields, or two sets of interlaced lines. In a film, a frame is one still picture of a series that makes up a motion picture.
- **“Gamma”**: The light output of a CRT is not linear with respect to the voltage input. The difference between what you should have and what is actually output is known as gamma.
- **“HDMI” - High – Definition Multimedia Interface**: An interface used primarily in consumer electronics for the transmission of uncompressed high definition video, up to 8 channels of audio, and control signals, over a single cable. HDMI is the de facto standard for HDTV displays, Blu-ray Disc players, and other HDTV electronics. Introduced in 2003, the HDMI specification has gone through several revisions.
- **“HDSDI”**: The high-definition version of SDI specified in SMPTE-292M. This signal standard transmits audio and video with 10 bit depth and 4:2:2 color quantization over a single coaxial cable with a data rate of 1.485 Gbit/second. Multiple video

resolutions exists including progressive 1280x720 and interlaced 1920x1080 resolution. Up to 32 audio signals are carried in the ancillary data.

- **“JPEG” (Joint photographic Expects Group):** Commonly used method of lossy compression for photographic images using a discreet cosine transfer function. The degree of compression can be adjusted, allowing a selectable tradeoff between storage size and image quality. JPEG typically achieves 10:1 compression with little perceptible loss in image quality. Produces blocking artifacts.
- **“MPEG”:** Motion Picture Expect Group. A standard committee under the auspices of the International Standards Organization working on algorithm standards that allow digital compression, storage and transmission of moving image information such as motion video, CD-quality audio, and control data at CD-ROM bandwidth. The MPEG algorithm provides inter-frame compression of video images and can have an effective compression rate of 100:1 to 200:1.
- **“NTSC”:** The color video standard used in North America and some other parts of the world created by the National Television Standards Committee in the 1950s. A color signal must be compatible with black-and-white TV sets. NTSC utilizes an interlaced video signals, 525 lines of resolution with a refresh rate of 60 fields per second (60 Hz). Each frame is comprised of two fields of 262.5 lines each, running at an effective rate of 30 frames per second.
- **“Operator”:** Refers to the person who uses the system.
- **“PAL”:** Phase Alternate Line. A television standard in which the phase of the color carrier is alternated from line to line. It takes four full pictures (8 fields) for the color-to-horizontal phase relationship to return to the reference point. This alternation helps cancel out phase errors. For this reason, the hue control is not needed on a PAL TV set. PAL, in many transmission forms, is widely used in Western Europe, Australia, Africa, the Middle East, and Micronesia. PAL uses 625-line, 50-field (25 fps) composite color transmission system.
- **“PIP”:** Picture-in-Picture. A small picture within a larger picture created by scaling down one of the images to make it smaller. Each picture requires a separate video source such as a camera, VCR, or computer. Other forms of PIP displays include Picture-by-Picture (PBP) and Picture-with-Picture (PWP), which are commonly used with 16:9 aspect display devices. PBP and PWP image formats require a separate scaler for each video window.
- **“Polarity”:** The positive and negative orientation of a signal. Polarity usually refers to the direction or a level with respect to a reference (e.g. positive sync polarity means that sync occurs when the signal is going in the positive direction).
- **“RJ-45”:** Registered Jack-45. A connector similar to a telephone connector that holds up to eight wires, used for connecting Ethernet devices.
- **“RS-232”:** An Electronic Industries Association (EIA) serial digital interface standard specifying the characteristics of the communication path between two devices using either DB-9 or DB-25 connectors. This standard is used for relatively short-range communication and does not specify balanced control lines. RS-232 is a serial

control standard with a set number of conductors, data rate, word length, and type of connector to be used. The standard specifies component connection standards with regard to the computer interface. It is also called RS-232-C, which is the third version of the RS-232 standard, and is functionally identical to the CCITT V.24 standard.

- **“Saturation”**: Chroma, chroma gain. The intensity of the color, or the extent to which a given color in any image is free from white. The less white in a color, the truer the color or the greater its saturation. On a display device, the color control adjusts the saturation. Not to be confused with the brightness, saturation is the amount of pigment in a color, and not the intensity. Low saturation is like adding white to the color. For example, a low-saturated red looks pink.
- **“Scaling”**: A conversion of a video or computer graphic signal from a starting resolution to a new resolution. Scaling from one resolution to another is typically done to optimize the signal for input to an image processor, transmission path or to improve its quality when presented on a particular display.
- **“SDI”**: Serial Digital Interface. The standard based on a 270 Mbps transfer rate. This is a 10-bit, scrambled, polarity independent interface with common scrambling for both component ITU-R 601 and composite digital video and four channels of (embedded) digital audio.
- **“Seamless Switching”**: A feature found on many video switchers. This feature causes the switcher to wait until the vertical interval to switch. This avoid a glitch (temporary scrambling) which normally is seen when switching between sources.
- **“SMPTE”**: Society of Motion Picture and Television Engineers. A global organization, based in the United States, that sets standards for baseband visual communications. This includes film as well as video and television standards.
- **“S-Video”**: A composite video signal separated into the luma (“Y” is for luma, or black and white information; brightness) and the chroma (“C” is an abbreviation for chroma, or color information).
- **“Sync”**: Synchronization. In video, sync is a means of controlling the timing of an event with respect to other events. This is accomplished with timing pulses to insure that each step in a process occurs at the correct time. For example, horizontal sync determines exactly when to begin each horizontal scan line. Vertical sync determines when the image is to be refreshed to start a new field or frame. There are many other types of sync in video system.(Also known as “sync signal” or “sync pulse.”)
- **“TCP/IP”**: Transmission Control Protocol/Internet Protocol. The communication protocol of the Internet. Computers and devices with direct access to the Internet are provided with a copy of the TCP/IP program to allow them to send and receive information in an understandable form.
- **“USB”**: Universal Serial Bus. USB was developed by seven PC and telecom industry leaders (Compaq, DEC, IBM, Intel, Microsoft, NEC, and Northern Telecom). The goal was easy plug-and-play expansion outside the box, requiring no additional

circuit cards. Up to 127 external computer devices may be added through a USB hub, which may be conveniently located in a keyboard or monitor. USB devices can be attached or detached without removing computer power. The number of devices being designed for USB continues to grow, from keyboards, mice, and printers to scanners, digital cameras, and ZIP drives.

- **“VESA”**: Video Electronics Standards Association. A nonprofit number organization dedicated to facilitating and promoting personal computer graphics through improved standards for the benefit of the end-user. www.vesa.org
- **“VGA”**: Video Graphics Array. Introduced by IBM in 1987, VGA is an analog signal with TTL level separate horizontal and vertical sync. The video outputs to a 15-pin HD connector and has a horizontal scan frequency of 31.5 kHz and vertical frequency of 70 Hz (Mode 1, 2) and 60 Hz (Mode 3). The signal is non-interlaced in modes 1, 2, and 3 and interlaced when using the 8514/A card (35.5 kHz, 86 Hz) in mode 4. It has a pixel by line resolution of 640×480 with a color palette of 16 bits and 256,000 colors.
- **“YCrCb”**: Used to describe the color space for interlaced component video.
- **“YPbPr”**: Used to describe the color space for progressive-scan (non-interlaced) component video.

5.4 Revision History

The table below lists the changes of MSP 315 User Manual.

Format	Time	ECO#	Description	Principal
V1.0	2019-11-19	0000#	Release	Fanny

All information herein is Xiamen RGBlink Science & Technology Co Ltd. excepting noted. RGBlink is a registered trademark of Xiamen RGBlink Science & Technology Co Ltd. While all efforts are made for accuracy at time of printing, we reserve the right to alter otherwise make change without notice. E&OM excepted.